

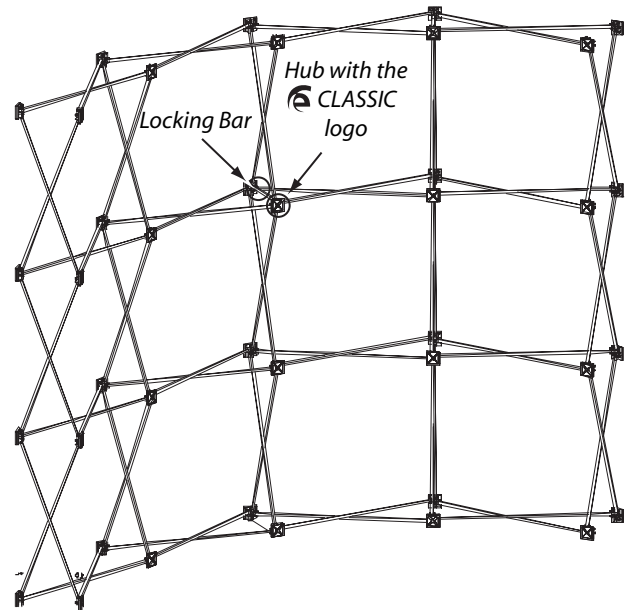

1. FRAME - Expanding the Frame

- A. Remove the panels from the case and unroll them, laying them flat on the floor. Laying them flat relaxes the "roll memory" and makes the panels easier to install.
- B. Expand the frame ensuring that the Classic logo hub, located in the center of the frame, is right side up and facing forward.
- C. If you ordered lights with your pop up, install them now by sliding the lights onto the brackets on the top of the frame
- D. Pull the frame upward until the locking bar extends past the frame, then relax the frame slightly and attach the locking bar.



IMPORTANT NOTICE: The locking bar is for set-up only. It MUST be RELEASED before hanging the panels. If the panels do not fit, then the locking bar has not been RELEASED.

2. HALOGEN LIGHT ASSEMBLY

- A. The halogen light is easy to attach. You'll find a special "seat" on the frame's top hubs. The "seat" provides the anchor for the base of the halogen light.
- B. Simply align the base of the halogen light as shown, and slide it onto the "seat" atop the frame hub.

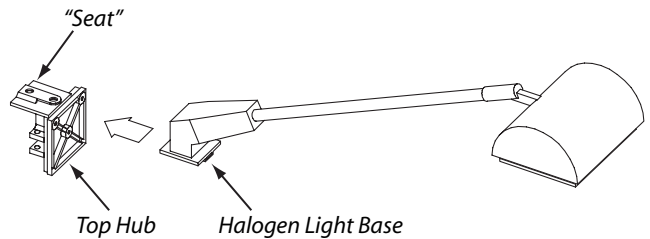

3. FRAME - Installing the Channel Bars

- A. The frame is now fully expanded with the "temporary" locking bar locked.
- B. There are 21 channel and slide bars to install on the 10 ft. frame. Place channel bars on frame with "top" stamp up and slide the top of the channel bar onto the bottom of the top hub until it hits the stop.

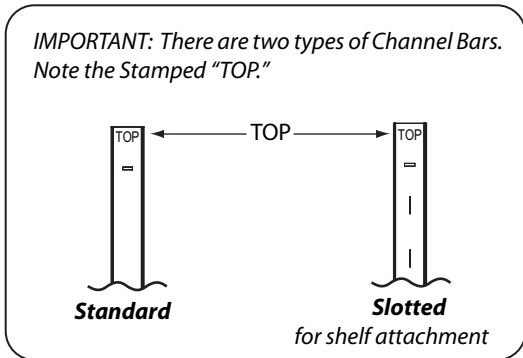

- C. Align the bottom edge of the channel bar over the top of the bottom hub. . .then slide down. Repeat until all channel bars are installed.
- D. Once all channel bars are installed, **lift up the locking bar and press down on back side of frame until all channel bars touch each other.** Due to the thickness of some carpets, you may have to rock the frame into place.

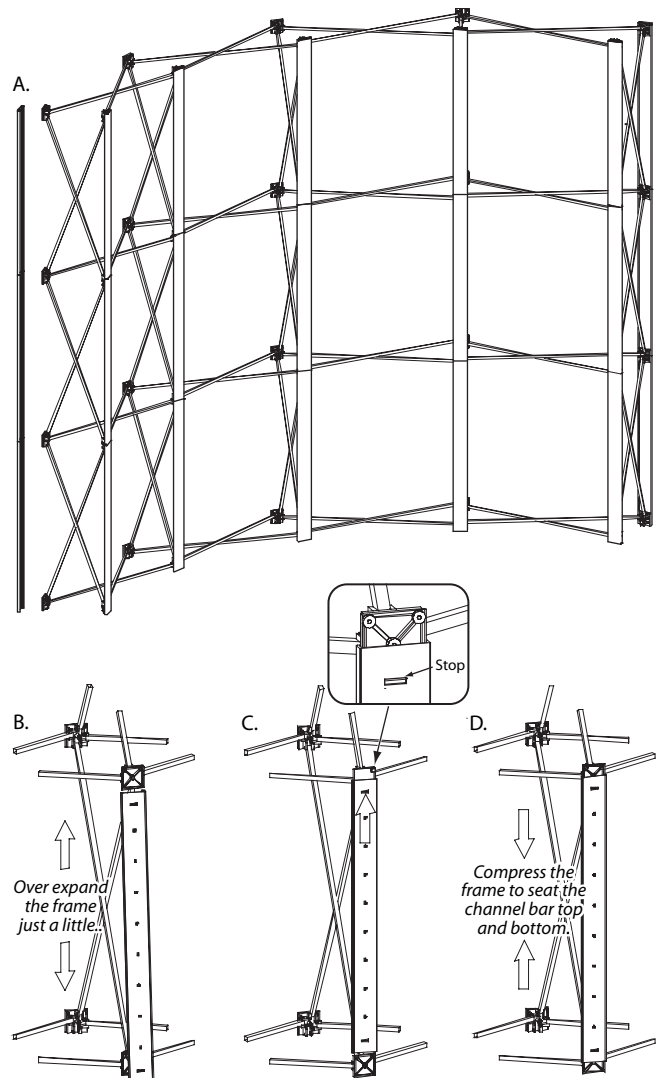



4. Attaching Panels - Curved & Straight Frame Units

- A. When placing panels on the frame, it is important to start at the center and work your way outward.
- B. Place panel on the frame by placing the hanger pin through the keyhole. Then release the bottom of the panel, allowing the panel magnets to adhere to channel bars.
- C. Then align the panel to the center dots on the channel bars.
- D. Repeat steps 1-3 until all panels are installed.

TIP: Attach halogen lights prior to hanging your panels. Much easier!

IMPORTANT NOTICE: When attaching the end panels, simultaneously join both front and back magnetic strips to the channel bars by using both hands. Curved frame end panels have Velcro dots on the bottom corners of each panel which match Velcro dots on the bottom corner hubs.

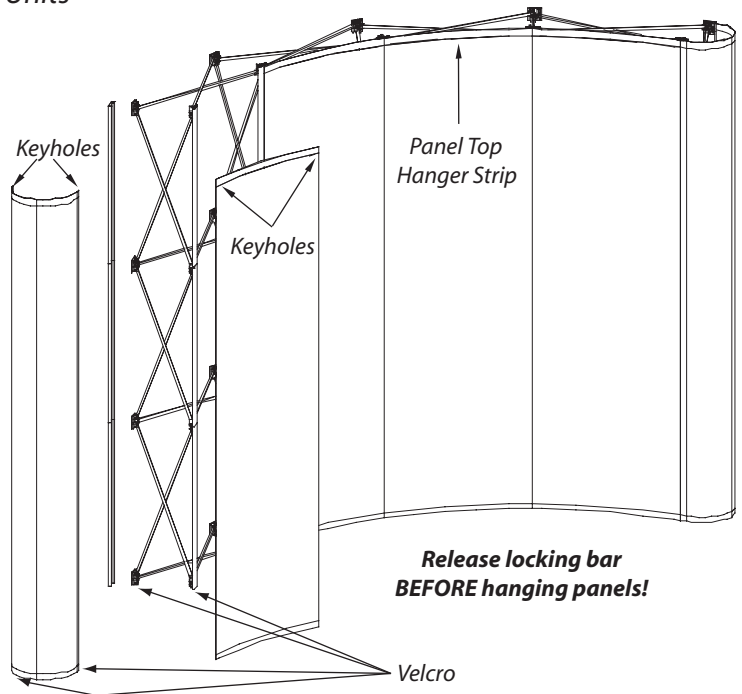

5. PACKING DIAGRAMS

10' CURVED DISPLAY... (2) Cases, (2) Halogen Lights (optional)

10' CURVED DISPLAY with CASE-to-COUNTER CONVERSION KIT... (2) Cases, (2) Halogen Lights (optional)

CASE #1

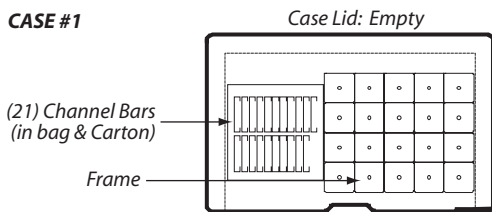

CASE #1

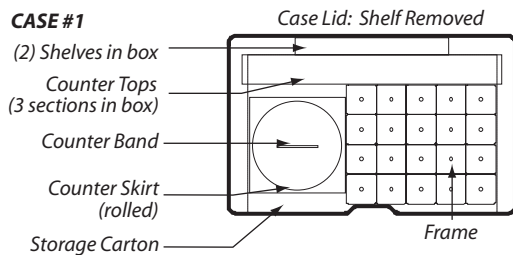

CASE #2

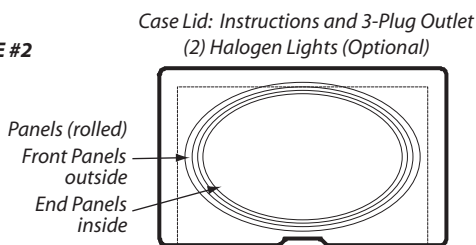

CASE #2

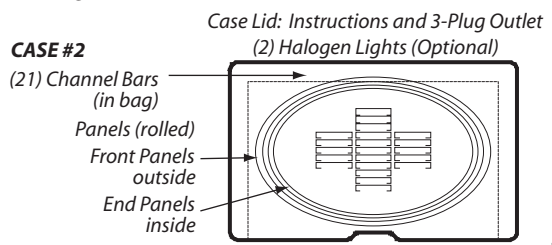

6. RECTANGLE CASE-TO-COUNTER KIT

FOUNDATION

- A. Position the cases, handles inward.
- B. Install (2) shelves.
- C. Wrap the bottom collar, velcro outward, around the cases. Connect the velcro ends.

TOP

- E. Lay the top middle piece upside down, and attach the 2" wide magnetic strips to it. Extend the hinges outward.
- F. Position the middle piece over the cases.
- G. Assemble the remaining (2) side pieces.

SKIRT

- H. Wrap the skirt around the cases, attaching to the top velcro first, then to the bottom.

Begin with the skirt's white-striped end at the right side of the opening between the cases.

